

## 60V P-Ch Power MOSFET

### Feature

- ◇ High Speed Power Switching, Logic Level
- ◇ Enhanced Avalanche Ruggedness
- ◇ 100% UIS Tested, 100% Rg Tested
- ◇ Lead Free, Halogen Free

### Application

- ◇ Load Switches
- ◇ Hard Switching and High Speed Circuit
- ◇ BLDC Motor

$V_{DS}$		-60	V
$R_{DS(on),typ}$	$V_{GS}=10V$	34	$m\Omega$
$R_{DS(on),typ}$	$V_{GS}=4.5V$	44	$m\Omega$
$I_D$ (Silicon Limited)		-26	A

Part Number	Package	Marking
HTD410P06	TO-252	TD410P06

TO-252

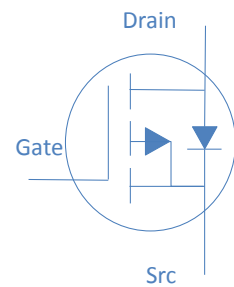
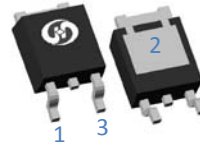

### Absolute Maximum Ratings at $T_j=25^\circ\text{C}$ (unless otherwise specified)

Parameter	Symbol	Conditions	Value	Unit
Continuous Drain Current (Silicon Limited)	$I_D$	$T_C=25^\circ\text{C}$	-26	A
		$T_C=100^\circ\text{C}$	-18	
Drain to Source Voltage	$V_{DS}$	-	-60	V
Gate to Source Voltage	$V_{GS}$	-	$\pm 20$	V
Pulsed Drain Current	$I_{DM}$	-	-60	A
Avalanche Energy, Single Pulse	$E_{AS}$	$L=0.1\text{mH}, T_C=25^\circ\text{C}$	20	mJ
Power Dissipation	$P_D$	$T_C=25^\circ\text{C}$	60	W
Operating and Storage Temperature	$T_J, T_{stg}$	-	-55 to 175	$^\circ\text{C}$

### Absolute Maximum Ratings

Parameter	Symbol	Max	Unit
Thermal Resistance Junction-Ambient	$R_{\theta JA}$	50	$^\circ\text{C/W}$
Thermal Resistance Junction-Case	$R_{\theta JC}$	2.5	$^\circ\text{C/W}$

**Electrical Characteristics at  $T_J=25^{\circ}\text{C}$  (unless otherwise specified)**
**Static Characteristics**

Parameter	Symbol	Conditions	Value			Unit
			min	typ	max	
Drain to Source Breakdown Voltage	$V_{(BR)DSS}$	$V_{GS}=0V, I_D=-250\mu A$	-60	-	-	V
Gate Threshold Voltage	$V_{GS(th)}$	$V_{GS}=V_{DS}, I_D=-250\mu A$	-1.0	-1.8	-3.0	
Zero Gate Voltage Drain Current	$I_{DSS}$	$V_{GS}=0V, V_{DS}=-48V, T_J=25^{\circ}\text{C}$	-	-	-1	$\mu A$
		$V_{GS}=0V, V_{DS}=-40V, T_J=125^{\circ}\text{C}$	-	-	-25	
Gate to Source Leakage Current	$I_{GSS}$	$V_{GS}=\pm 20V, V_{DS}=0V$	-	-	$\pm 100$	nA
Drain to Source on Resistance	$R_{DS(on)}$	$V_{GS}=-10V, I_D=-20A$	-	34	41	m $\Omega$
		$V_{GS}=-4.5V, I_D=-10A$	-	44	54	
Transconductance	$g_{fs}$	$V_{DS}=-5V, I_D=-20A$	-	32	-	S
Gate Resistance	$R_G$	$V_{GS}=15mV, V_{DS}=0V, f=1MHz$	-	6.5	-	$\Omega$

**Dynamic Characteristics**

Input Capacitance	$C_{iss}$	$V_{GS}=0V, V_{DS}=-25V, f=1MHz$	-	2975	-	pF
Output Capacitance	$C_{oss}$		-	240	-	
Reverse Transfer Capacitance	$C_{rss}$		-	150	-	
Total Gate Charge	$Q_g(10V)$	$V_{DD}=-30V, I_D=-20A, V_{GS}=-10V$	-	45	-	nC
Gate to Source Charge	$Q_{gs}$		-	8.0	-	
Gate to Drain (Miller) Charge	$Q_{gd}$		-	7.5	-	
Turn on Delay Time	$t_{d(on)}$	$V_{DD}=-10V, I_D=-1A, V_{GS}=-10V, R_G=6\Omega,$	-	12	-	ns
Rise time	$t_r$		-	15	-	
Turn off Delay Time	$t_{d(off)}$		-	40	-	
Fall Time	$t_f$		-	20	-	

**Reverse Diode Characteristics**

Diode Forward Voltage	$V_{SD}$	$V_{GS}=0V, I_F=-17A$	-		1.3	V
Reverse Recovery Time	$t_{rr}$	$I_F=-5A, dI_F/dt=100A/\mu s$	-	40	-	ns
Reverse Recovery Charge	$Q_{rr}$		-	60	-	nC

Fig 1. Typical Output Characteristics

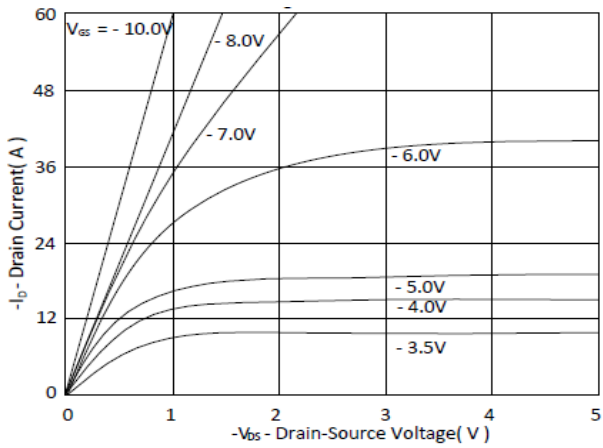

Figure 2. On-Resistance vs. Gate-Source Voltage

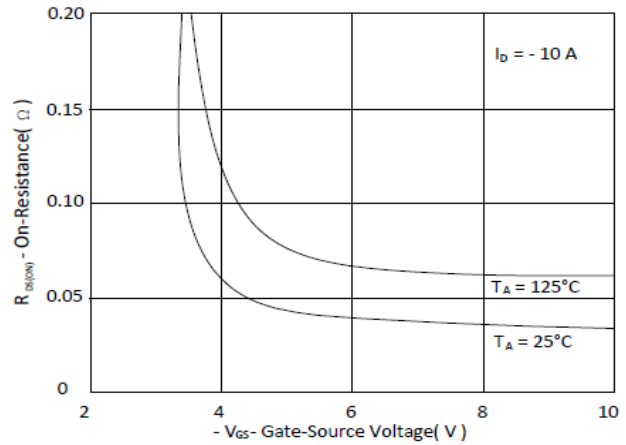

Figure 3. On-Resistance vs. Drain Current and Gate Voltage

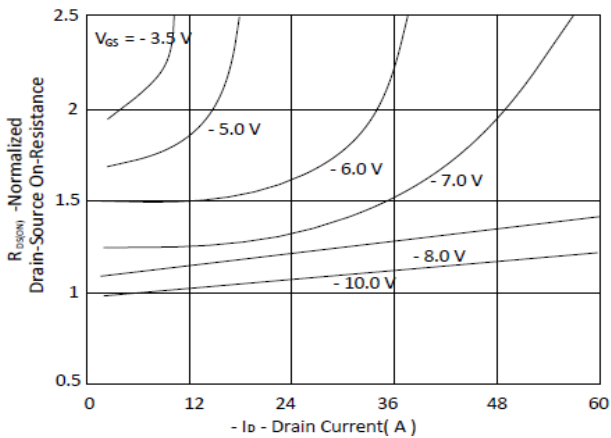

Figure 4. Normalized On-Resistance vs. Junction Temperature

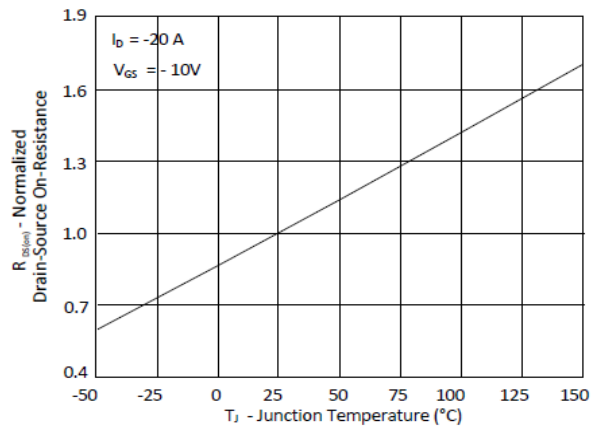

Figure 5. Typical Transfer Characteristics

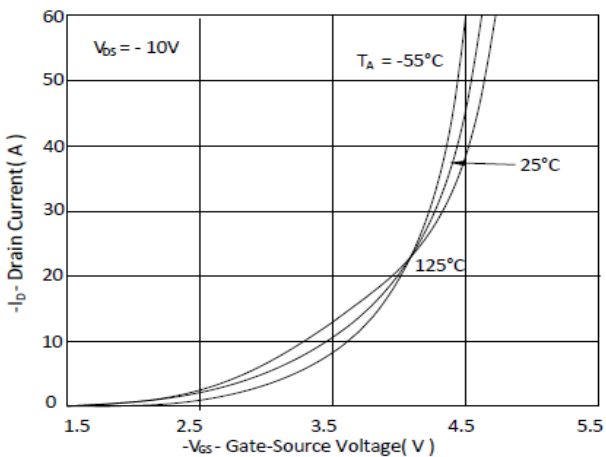

Figure 6. Typical Source-Drain Diode Forward Voltage

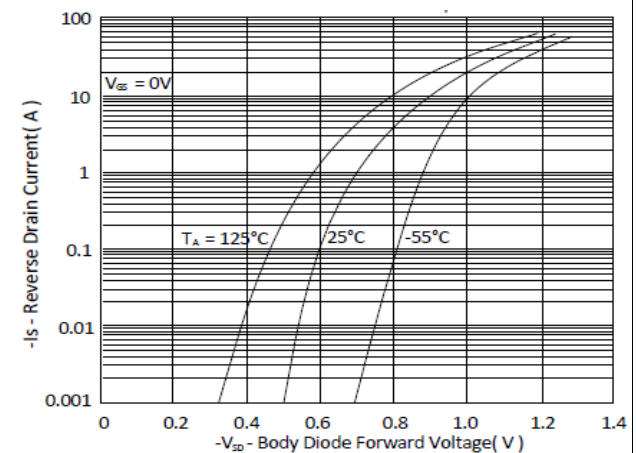

Figure 7. Typical Gate-Charge vs. Gate-to-Source Voltage

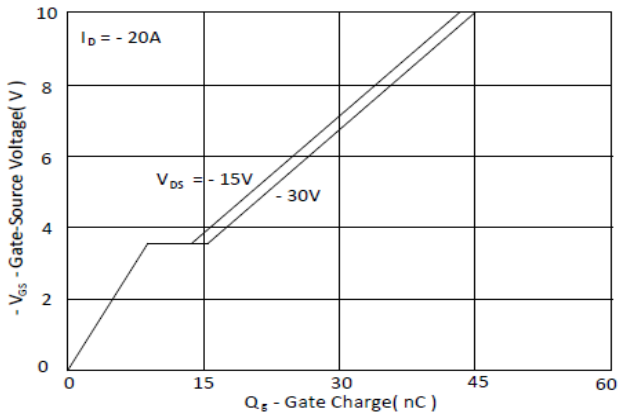

Figure 8. Typical Capacitance vs. Drain-to-Source Voltage

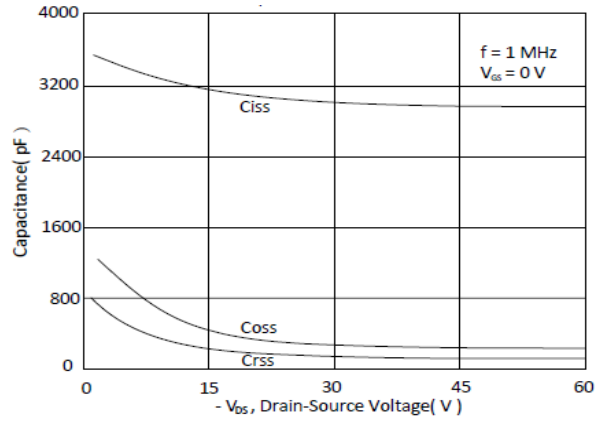

Figure 9. Maximum Safe Operating Area

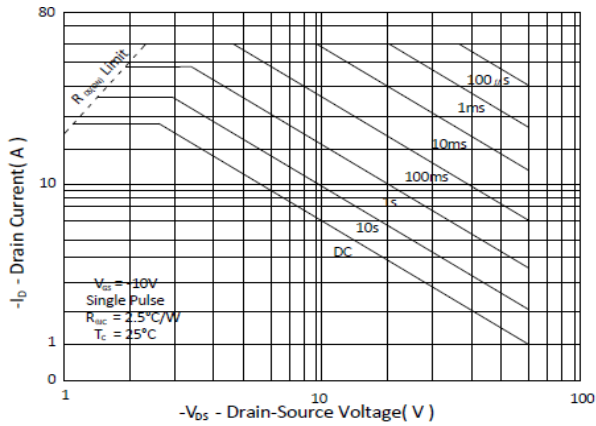

Figure 10. Single Pulse Maximum Power Dissipation

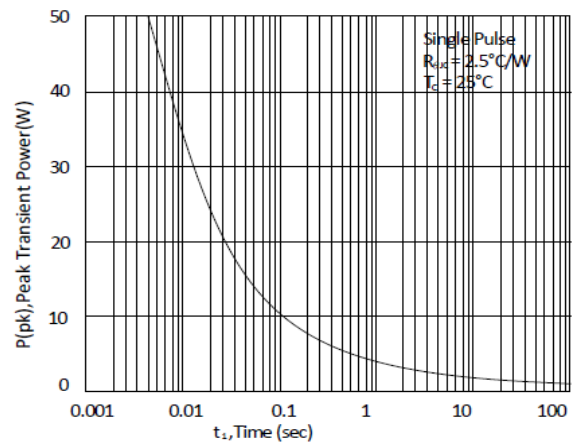
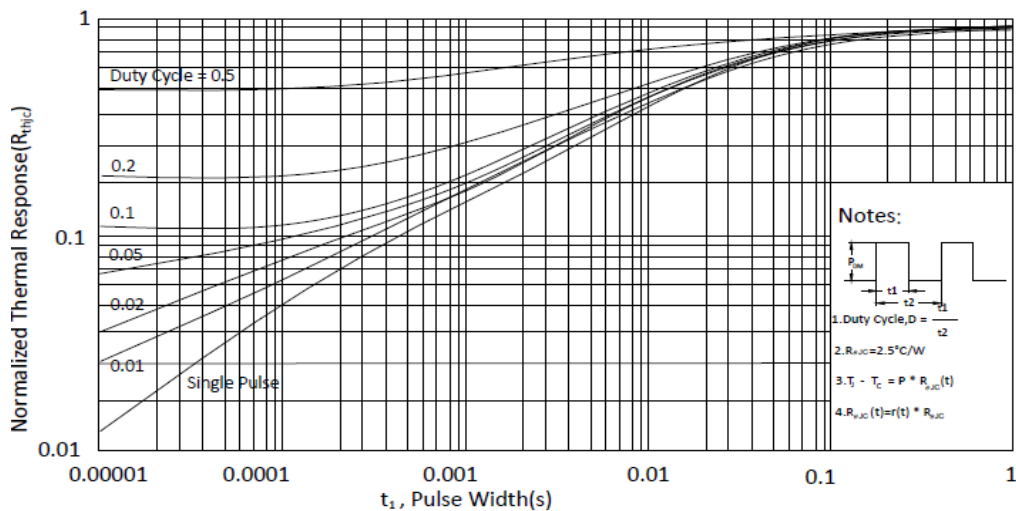
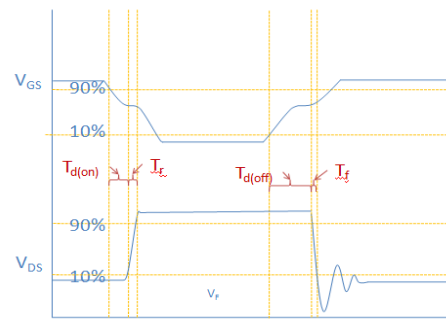
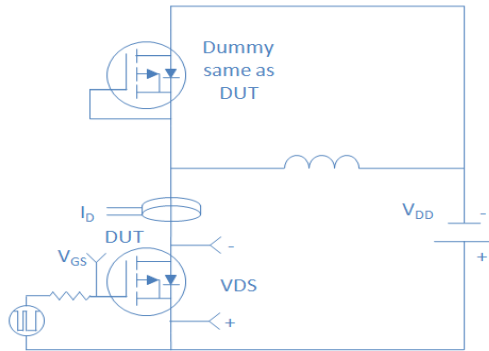

Figure 11. Normalized Maximum Transient Thermal Impedance, Junction-to-Ambient



Inductive switching Test



Gate Charge Test

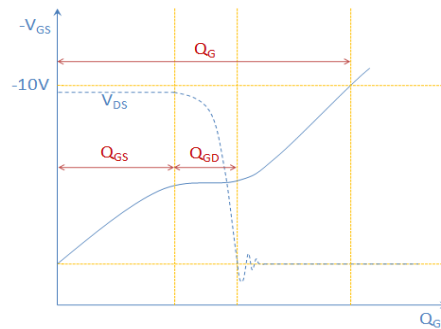
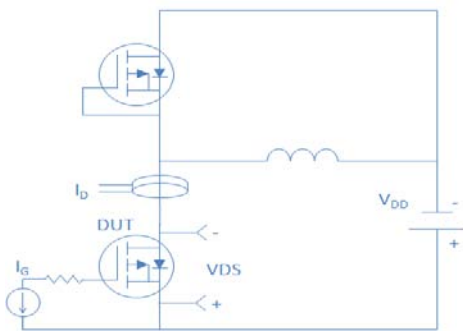

Uclamped Inductive Switching (UIS) Test

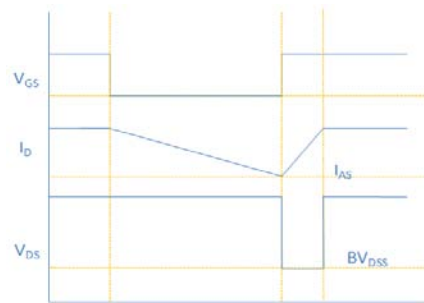
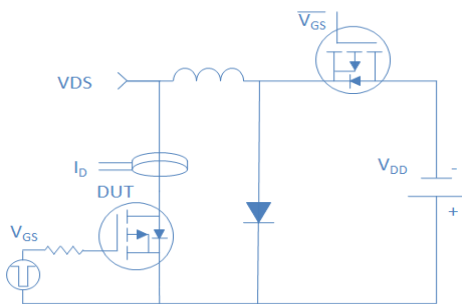

Diode Recovery Test

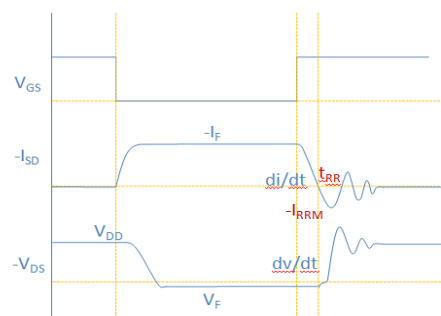
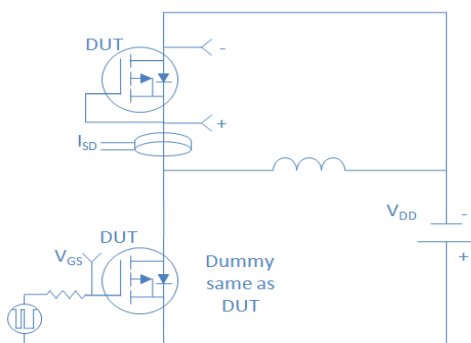

Package Outline

TO-252, 3leads

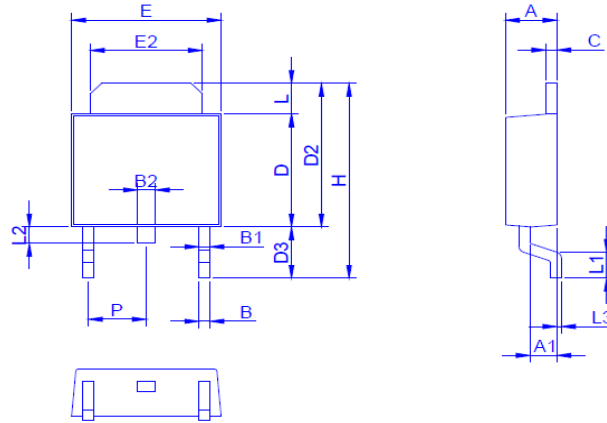

Dimension	A	A1	B	B1	B2	C	D	D2	D3	E	E2	H	L	L1	L2	L3	P
Min.	2.10	0.95	0.30	0.40	0.60	0.40	5.30	6.70	2.20	6.40	4.80	9.20	0.89	0.90	0.50	0.00	2.10
Max.	2.50	1.30	0.85	0.94	1.00	0.60	6.20	7.30	3.00	6.70	5.45	10.15	1.70	1.65	1.10	0.30	2.50